

UFM-T 05 standard / superplus

UFM-T 1/10/20

UFM-T 100/20HP



The zero-loss condensate drain

Product description:

The UFM-T's are compressed air zero-loss, electronically controlled condensate drains.

The diaphragm operation and the large internal cross-sections for draining ensure reliable operation even when dealing with dirty, particle polluted condensate:

Less downtime, less trouble and more safety for the application.

Additionally the condensate becomes less emulsified – when compared with time controlled solenoid valves which spray/atomise the condensate. Less emulsification results in better function of oil/ water separators: longer compliance with legal discharge limits, less running costs! As there is no air-loss whilst purging these drains work silent – a very important feature when this drain is installed within a working area: No noise nuisance anymore!

The electronic control of the drain monitors the proper operation continuously.

Automatic malfunction routines and a potential free alarm contact for remote control ensures safe operation at all times. You can react to malfunctions before they are obvious by water in the condensate line at the point of use!

Applications:

Compressed air zero-loss draining of condensate at:

- compressors
- aftercoolers
- receiver-vessels
- pre- and after-filters of fridge dryers
- pre-filters of adsorption dryers
- condensate- and oil-removal filters
- pipe bends

Features:	Benefits:
Zero-loss	No expensive air-losses, silent operation, less emulsification of the condensate
Aluminium parts coated, diaphragm and O-rings from VITON	Suitable for the aggressive condensate of oil-free compressors.
UFM-T05/T1/T10 and T20: Voltage range from 24 to 230 V	Universal use world-wide
Info channel	Serial interface for the connection of the Programmer; Individual setting of control parameters (applies to UFM-T1, 10, 20, 100, 20HP and UFM-T05 superplus)
Connection power supply/ alarm contact	Via plugs according to DIN 43650, design C; Housing does not have to be opened; More simply for service and installation (applies to UFM-T1, 10, 20, 100, 20HP and UFM-T05 superplus)
Electronic control	Automatic malfunction routines, continuous control of operation, potential-free alarm contact for remote control
Sloped display	Easy reading of function LED and easy use of the manual purge button even if the drain is installed above eye-level
Sensors without moving parts	Safe function without sticking or blocking of the drain
Condensate inlet from the top	Quick and easy installation under filter housings
Alternative condensate inlet on ground level	Quick and easy installation under low ground clearance conditions
Condensate inlet vertically and horizontally by a turnable elbow adapter (UFM-T05 only)	Quick and easy installation to different pipings (UFM-T05 only)

Materials:	
Top (thread) (not T05)	Aluminium, coated
Parts under pressure	glass fibre re-inforced plastic
Diaphragm and O-rings	VITON

Temperature range:	
Without heater	+1°C to +60°C
With heater	-20°C to +60°C

Option:	
Heater	24 V; 110 V; 230 V
Programmer	superplus

Service parts:
Set: O-rings, diaphragm, springs, anchor plate

Options:

Adapter with integrated vent for UFM-T10,T20.

Type	Power supply	Alarm contact	Protection	Power consumption	
				without heater	with heater
T05	24 - 230 V _{DC} 90 - 230 V _{AC} 50 - 60 Hz	only T05 SP 230 V _{AC/DC} 0,092 A	IP 65	7 W	*/*
T1				5 W	25 W
T10					
T20					
T100	24 V _{DC} 110 - 230 V _{AC} 50 - 60 Hz	300 V _{DC} 247 V _{AC} 0,092 A			*/*
T20 HP					

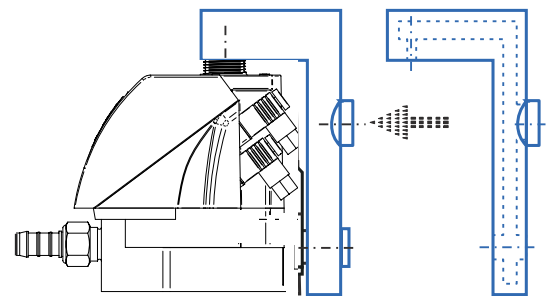

Adapter to 1/2" (T100: 3/4")
BSP or NPT for installation under filter housings;
bolt connection with coupling ring.

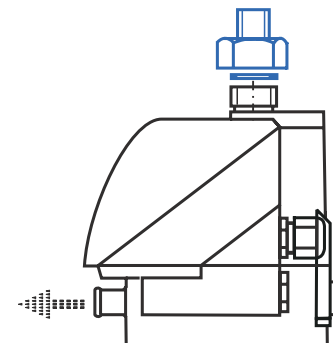

Type	Pressure range (bar)	Capacities ¹⁾ (m ³ / min)			
		Compressor	Fridge Dryers	Filter	
T05	0.8-17.2	5	30 kW	10	50
T1	0.8-16	10	60 kW	20	100
T10		20	120 kW	40	200
T20		100	600 kW	200	1000
T100		100	600 kW	200	1000
T20 HP	1,2-42	100	600 kW	200	1000

¹⁾ Nominal capacities are related to moderate climate for example: inlet conditions : 1 bar a, 20°C, 70% r.F. / 7 bar ü (UFM-T20HP 40 bar ü), 35°C, 100% r.F.

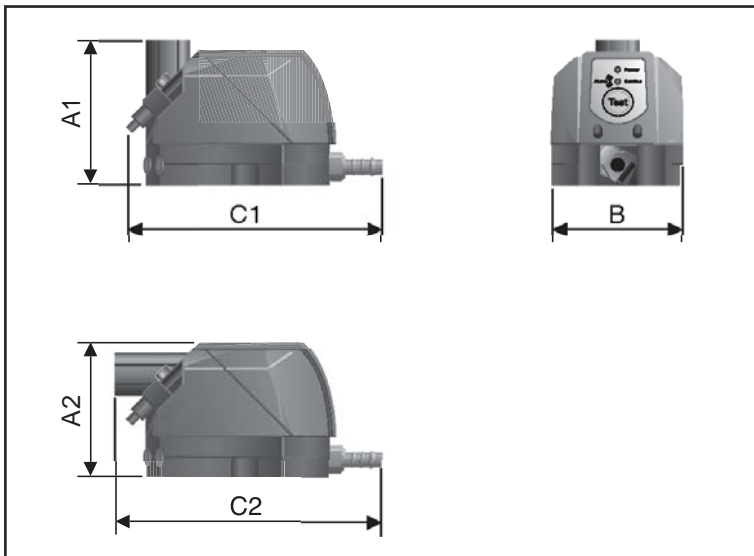

T 05

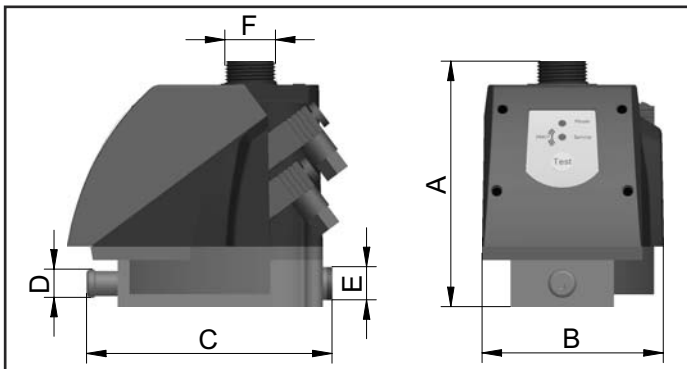
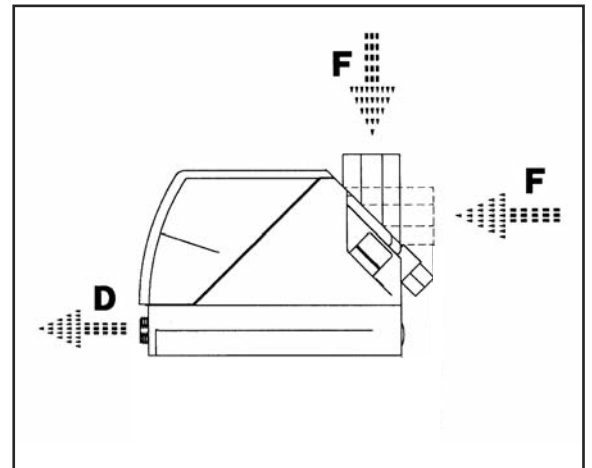

T 1 / T 10

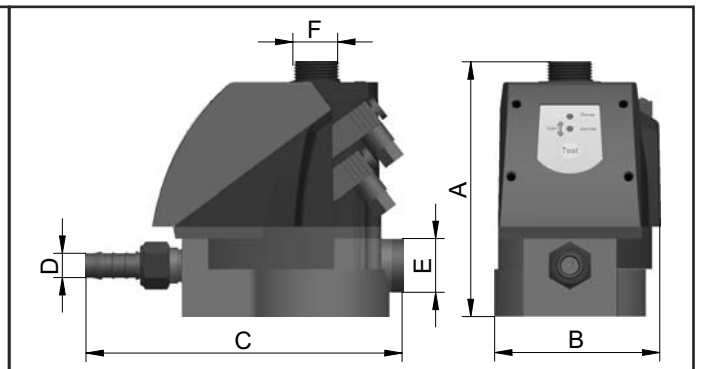

T 20

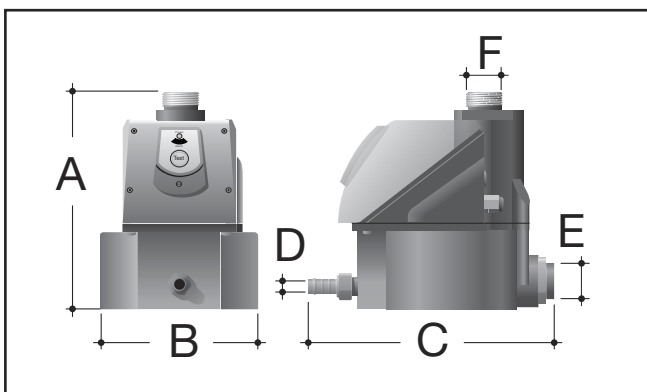

T 100 / T 20 HP

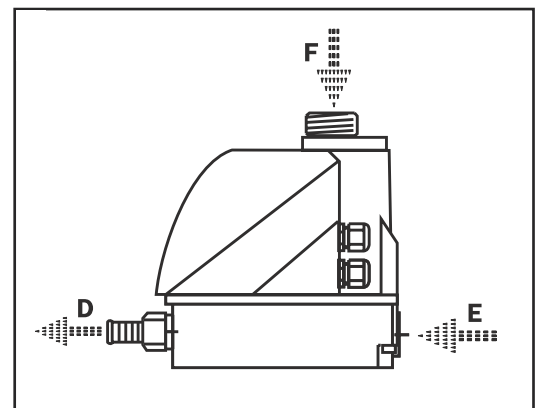

Type	Weight (kg)	A/A1/A2 mm	B mm	C1/C2 mm	øD mm	E mm	F mm
T 05	0.7	100/92	90	130 / 145	13	*/*	G 1/2
T 1	0.9	126	95	124			G 1/2
T 10	1.0	133		144			
T 20	1.2	147		175			
T 100	3.7	203	150	240	14	G 3/4	G 1
T 20 HP	3.3	191	114	245			